

Felsham & Gedding

VILLAGE NEWS

Issue 196, June 2020

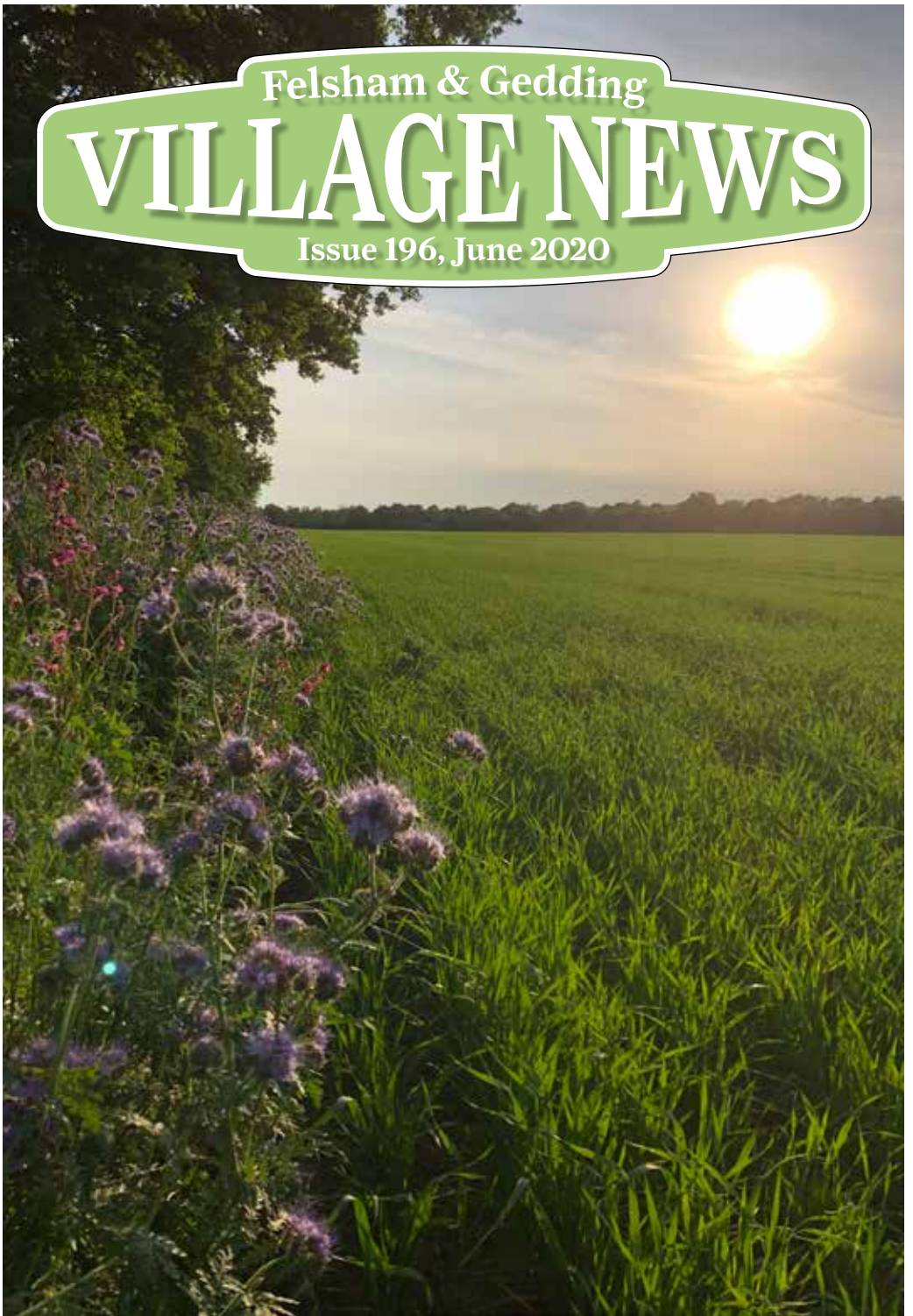

Welcome to the June edition of your *Felsham & Gedding Village News*.

It's been almost two months since I was Furloughed. The "new normal" has very much become just *normal*, as we have adapted to lockdown life and the ebb and flow of the daily routine at home.

Everyone's life has been changed in some way, in many respects for the better, and at home we've been asking ourselves what positives will we take forward when we (eventually) return to the "old normal" (or will that be "new, old normal")?

One thing we've already vowed to do is to continue to make more use of the Village Store. We've been making at least a couple of trips every week and this has lead to a household addiction for chocolate eclairs and porridge oats from Pakenham Mill.

The volunteers have been doing great work, both in the store and making deliveries to those who cannot get there in person. It's fair to say they all deserve our heartfelt thanks.

Stay safe everyone.

Richard

Next Copy Date

23/04/2019

Please be aware that items submitted after the deadline cannot be guaranteed to appear in the magazine.

Copy Submissions

Email villagenews@felsham.org.uk or call Jo Tavernor on 01449 737793

Advertising

Email villagenewsadverts@felsham.org.uk or call Jo Tavernor on 01449 737793

Copy Submissions

Email villagenews@felsham.org.uk or call Jo Tavernor on 01449 737793

Compliments, Complaints & Suggestions

The Village News team would welcome your feedback. Do you have any comments about what we do, what's going well, anything you'd like us to change?

Email jsthorticulture@btinternet.com or call Jo Tavernor 01449 737793

Newsletter General Policy

We do publish acknowledgements, articles of general interest, artistic works and similar.

We do publish factual material from recognised organisations.

We do publish to the Village web site at <http://felsham.onesuffolk.net/>

We do not publish defamatory, rude, blasphemous, racial or other inappropriate material.

We reserve the right to edit contributions to suit publication needs.

We are reliant on contributions from many sources, taken in good faith, and cannot be held responsible for any errors or omissions.

Copyright waiver is presumed implicit on all submissions unless clearly stated otherwise.

Felsham and Gedding Village Hall Management Committee

Annual General Meeting 2020 will be held on Tuesday 16th June at 7.30pm. All Welcome!

New committee members needed and any support much appreciated!

If you wish to come along (or join via Zoom if still socially distancing) please contact me directly via e-mail at jospanner6@yahoo.com or telephone 07855 321183.

Thanks, Jo.



Felsham & Gedding Community Store

We have recently received the letter reproduced on the following page. *Volunteers of the Community Store - please read and be very proud of yourselves!* The Committee would also like to take this opportunity to say a big thank you to everyone for all the support you have given us during the lockdown.

We are continuing to make home deliveries. Simply phone your order through in the morning (01449 736042) and it will be delivered either that afternoon or evening.

Orders for Lavenham Butchers would generally be delivered the following day, and Lavenham Bakers deliver on Monday, Wednesday, Friday and Saturday. Please bear this in mind when placing your order.

Thank you to all of our customers who have and continue to comply with our social distancing measures whilst at the store.

Spot the Difference

Can you find the **six** differences between the two pictures below?



THE BAILEY STABLES
EUSTON
SUFFOLK
IP16 2JY

Clare, Countess of Euston
H.M. Lord-Lieutenant for Suffolk

Ria Crosbie
Felsham and Gedding Community Shop
Church Road
Felsham
Suffolk
IP30 OPJ

21st May 2020

Joan Ria

I am writing to you today as her Majesty the Queen's personal representative here in Suffolk.

These are exceptionally difficult times for our villages and our communities. Yet despite the uncertainty and the sadness, I am hearing every day of extraordinary acts of kindness as neighbours pull together to help the most vulnerable in their communities.

Suffolk's Community Shops have been central to this work and I have been told what a fantastic job you all do in Felsham. Without you, life could be unbearable for so many more friends and neighbours. You are the ray of light that shows that we will get through this challenge together.

Please accept the deepest gratitude to you, your colleagues, and your community for all you are doing to support each other.

*Best wishes
Clare Euston*

Clare, Countess of Euston
H.M. Lord Lieutenant of Suffolk

Telephone: 01449 74744
Email: liaison@felshamandgedding.org.uk



01638 428 060
www.Rothwells.biz

Carpet Cleaning

Stone Floor, Upholstery & Rug Cleaning.

A few points that make us stand out from the others,

Rothwell's has been in business since 1993.

We're an honest local family firm.

Our large truck mounted machines mean more cleaning & drying power for the best results possible.

Members of both the NCCA and TACCA.

We will move the furniture for a thorough clean.

100% satisfaction or it's FREE.

Call Oliver and Max Campbell for expert help today.

Rothwell's, Malting End, Kirtling, Newmarket, CB8 9HH

Citizens Advice Mid Suffolk

Citizens Advice Mid Suffolk provide advice on problems at work, help people struggling to pay their bills and work out if people are getting all the financial help they are entitled to. We are a local charity and our advice is free.

Opening times: Monday - Thursday, 9.30am - 3.30pm
Friday 9.30am - 12.30pm

Call us on **01449 676060** or visit **www.midsuffolkcab.org.uk**

If you have any questions please let us know. We are keen to do everything we can to support people in our community during the coronavirus crisis.



Licensed cloud based bookkeeping practice

Working side by side with entrepreneurs
to take control of their business finances!

Genie Services include:

- ☆ Weekly & Monthly Bookkeeping
- ☆ Payroll Services
- ☆ Preparing & Submitting VAT Returns
- ☆ Cloud Set up & Training
- ☆ Annual Accounts for Sole Traders & Partnerships



+44 7309 600 007
phina@a-counting-genie.co.uk
www.a-counting-genie.co.uk



A AND C FENCING AND GARDENS

call Andy for free quote

**All fencing
garden maintenance
garden building work
grass and hedge cutting
concrete bases etc**

**01449 403050
07748 785197**

Number Snake

Can you complete this maths puzzle?

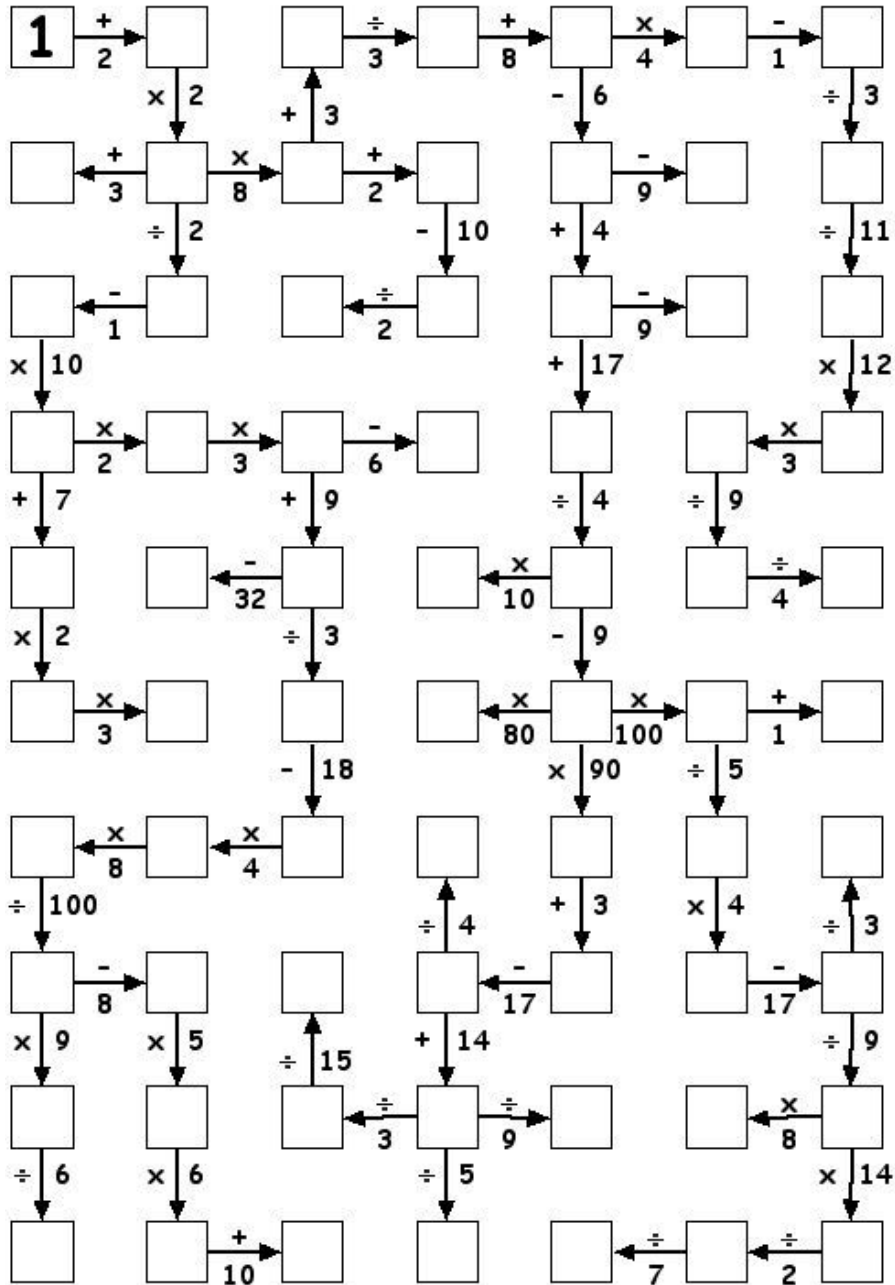

Can you order your "cerveza, vino y tapas?"



I CAN TEACH YOU!

Phone **Andrea**
on **01449 736955**

Friendly Experienced
Teacher
offers
**Individual MATHS
Tuition**
(Speciality - Confidence
Building)
KS2 – GCSE

Call Colin Plummer on
01449 736918
Or email colinp52@gmail.com
for details and availability

Valley Farm Piano and Cello Tuition



Experienced, qualified
teacher/professional accompanist.



Teaching all ages: beginners to advanced.

Accompanist for concerts, exams, rehearsals.

Contact: **Nicola Brazier.GRSM(Hons) ARCM LGSM**
Tel: **01449 737458**
Mob: **07531795064**
Email: nicobraz@hotmail.co.uk

Odd One Out Quiz

See if you can spot the odd one out in each of these ten sets of pictures. Answers on page 24.

<p>1</p> <p>Which vegetable is the odd one out?</p>				
<p>2</p> <p>Which country is the odd one out?</p>				
<p>3</p> <p>Which sport is the odd one out?</p>				
<p>4</p> <p>Which animal is the odd one out?</p>				
<p>5</p> <p>Which food is the odd one out?</p>				

Odd One Out Quiz

<p>6</p> <p>Which sea creature is the odd one out?</p>				
<p>7</p> <p>Which item is the odd one out?</p>				
<p>8</p> <p>Which creature is the odd one out?</p>				
<p>9</p> <p>Which instrument is the odd one out?</p>				
<p>10</p> <p>Which person is the odd one out?</p>				



Felsham & Gedding Village Hall

Available for hire

- Large Main Hall
- Separate room
- Fully Licensed Bar available
- Fully equipped Kitchen
- Stage available by arrangement
- Ample car parking
- Reasonable rates

For bookings call 01449 737778

WiFi available – password on request



Taylor's Solid Fuels LTD

Family run since 1946

Regular fortnightly Solid Fuel deliveries in your area.
Competitive prices and a full range of products.

“Don't Shiver We Deliver”

Quality top soils and aggregates. Bulk bags and Tipper loads from 1-20 tonnes

Tel: 01842890568 or see us on www.taylorssolidfuels.co.uk

CARGATE engineering

Septic Tank Emptying and Servicing

- Septic Tank and Cesspool Emptying • Tank and Drain Cleaning Service available • Reliable and Competitive • 24/7 Emergency Response
- Treatment Plant Service available • New Tanks installed
- Vehicles Covering East Anglia

Cargate Engineering Ltd,
Felsham Road, Bradfield St George,
Bury St Edmunds, Suffolk IP50 0AG

E-mail: n.milson@cargate-engineering.co.uk
www.cargateengineering.co.uk



01284 386538 (Head office)



CHIMNEY SWEEP

ECO SWEEP CHIMNEY SERVICES

- NEW POWER SWEEPING METHOD USED FOR A MORE THOROUGH CHIMNEY CLEAN THAN BRUSHES.
- INDUSTRIAL HEPA FILTERED VACUUM.
- FULLY INSURED.
- INSURANCE RECOGNIZED CERTIFICATES ISSUED.
- SPOTLESS, RELIABLE AND FRIENDLY SERVICE.
- ALL CHIMNEYS, WOOD BURNERS, AGA, BOILER FLUES SWEEP.
- GUILD OF MASTER SWEEPS CERTIFICATED MEMBER.



TEL. 01359 232335



MILES ROLFE JOINERY

Production, Design & Fitting of All
Aspects of Joinery & Furniture

Gt. Finborough • Suffolk







07880 776845 mobile
mrjoinery@live.com

01449 771338 evening
milesrolfejoinery.co.uk

Follow me on Facebook

June 2020

VH = Village Hall
VHCP = Village Hall Car Park

Monday	Tuesday	Wednesday	Thursday	Friday	Saturday	Sunday
1 John's Fresh Fruit & Veg Call 01449 736578	2	3	4 Mermaid Fish & Chips VHCP, 6 - 6:30pm	5 Mobile Library Gedding Village Sign, 10:10 and VHCP, 11:40am Fresh Fish, VHCP 10:05am BLACK BIN 	6	7 Morning Worship with Revd Sharon 10am, Facebook Live (see page 19)
8 John's Fresh Fruit & Veg Call 01449 736578	9	10	11 Mermaid Fish & Chips VHCP, 6 - 6:30pm BROWN BIN 	12 Fresh Fish, VHCP 10:05am GREEN BIN 	13	14 Worshiping Together with William Cardale 10am, Facebook Live (see page 19)
15 John's Fresh Fruit & Veg Call 01449 736578	16	17	18 Mermaid Fish & Chips VHCP, 6 - 6:30pm	19 Fresh Fish, VHCP10:05am BLACK BIN 	20	21 Family Service with Richard Stainer 10am, Facebook Live (see page 19)
22 John's Fresh Fruit & Veg Call 01449 736578	23	24	25 Mermaid Fish & Chips VHCP, 6 - 6:30pm BROWN BIN 	26 Fresh Fish, VHCP 10:05am GREEN BIN 	27	28 Communion with Revd Sharon 10am, Facebook Live (see page 19)
29 John's Fresh Fruit & Veg Call 01449 736578	30	29			All of the regular clubs and events have been cancelled due to the Coronavirus outbreak. The days and times for commercial services have been left on the calendar, but please check with the service provider they are still intending to visit the village at their usual times.	

The Cockfield Benefice

Dear Friends,

Today I visited Homebase, it was a joyous occasion as I wheeled my trolley around one of my favourite stores in Bury St Edmunds. I have to confess that I would rather shop in a DIY store than a fashion outlet! I needed some screws for the garden gate which my dog had managed to damage a couple of days ago, and I had to fix it to make it safe. It was lovely to be back in the store, even with social distancing!

It's just one of the things that I have missed during these past couple of months - some way down the list of course, but nevertheless a reminder that our personal freedom has been curtailed in order to try to prevent the spread of Covid-19. What I miss most of all is the company of other people, those that I worship, work and socialise with, as well as my family. For those of us who live alone, this has been the hardest part of lockdown.

But as we prepare to open our schools to pupils, and then our churches (at the time of writing it is thought we may be able to do so at the beginning of July) I can feel the levels of anxiety rising in the community. Of course we are wary, of course we are not sure whether this is the right time, but we will have to trust our government and its advisors, and of course follow the guidance that we are given.

Throughout this period people have been very kind to each other. There have been 'phone calls, social media messages and emails. When out on dog walks there have been conversations at a distance. There have been 'zoom' meetings, and there has been the opportunity to reach out to people in worship via the benefice facebook page.

At the heart of this period for me has been prayer. Prayer has sustained me - and many other Christians across the world. Prayer on my own in the Rectory. Prayer with others via video conferencing. Prayer at set times in the day as well as prayer at moments of distress or pain. As well as thankfulness prayers for all that I am lucky to have in this most beautiful part of the world.

For some, the thought of a being that has created and sustained us seems completely ludicrous. How can it be that people in the 21st century can believe in a force, a person, a thing without evidence that he/she/it exists?

And even if God does exist, and - as Christians claim - loves us as children, how can it be that God has allowed coronavirus to infiltrate and devastate our society? This is an age old question, and one that can't really be answered in a way that would satisfy most people. One of our lay ministers, Malcolm Gifford, gave me a book by John C Lennox which is entitled, 'Where is God in a coronavirus world?' It is a very short book of 62 pages, but I think it is very good at helping us to understand what God is really like, and where God is in the midst of all the pain and suffering that coronavirus has brought about.

What I have always known as a Christian is that God loves us very deeply, and will not force us to love Him. He created us in his image, and wants us to have life in all its fullness. Which means enjoying life, every second, every minute, every hour of every day. What I think this crisis has given many is an opportunity to slow down, to think and reflect about the lives that they have been living up to now. And it may have prompted them to make changes.

And so, whether you believe in God or not, I hope that you have had the opportunity to think about life, what you value, and what you can do without. I know I certainly have. And as we go forward into the future, may your resolutions to do things differently, if you've made them, work out well.

Stay safe, and know that you are loved by God.
In the name of Christ,

Revd Sharon

Revd Sharon Potter

revsharon@btinternet.com 01284 828599 or 07825 086063

Services in the Cockfield Benefice - June 2020 All being livestreamed via the benefice facebook page at https://www.facebook.com/cockfieldbenefice/live/		
7th June, Trinity Sunday	10am - Morning Worship	Revd Sharon
14th June, Trinity 1	10am - Worshipping Together	William Cardale
21st June, Trinity 2	10am - Family Service	Richard Stainer
28th June, Trinity 3	10am - Communion	Revd Sharon

The entry date for Beryl's Quiz has been extended to 14th June

ALTERNATIVE SERVICES

WINDOW CLEANING COMPANY

EST: 1991

We are a window cleaning company, have been around 20 years.

My name is Nigel.

If you would like a quote, please ring me or send an email.

Mob 07775 858052

Email nigel.mess22@ntlworld.com

PROFESSIONAL FOOT HEALTHCARE
IN THE COMFORT OF YOUR OWN HOME

FRIENDLY AND PROFESSIONAL
TREATMENT AND ADVICE

TEL: 07842 400302

Email: tishfayers@hotmail.co.uk

Patricia Fayers S.A.C.Dip. RFHP

HANDS UP!
NAIL STUDIO
IN
RATTLES DEN

CLASSIC MANICURE - £12
CLASSIC PEDICURE - £22

ANY QUESTIONS PLEASE CALL:

07889448186

HANDSUPMANICURE@GMAIL.COM
[INSTAGRAM.COM/HANDSUPMANICURE](https://www.instagram.com/handsupmanicure)

CERTIFIED NAIL MASTER
WITH DIPLOMA

Keith Bedwell's Building Services

Traditional Lime & Hair Plastering
Plastering & Rendering
Floor & Wall Tiling
Renovation & Restoration Work
General Maintenance



Call: 01449 257806
Mobile: 07870 371520

Email: info@keithbedwell.co.uk
Facebook: Keith Bedwell Building Services
Website: www.keithbedwell.co.uk

A N GILLAM

Building,
All aspects of roofing,
chimney work,
Lime plastering & rendering.
Chimney sweep

*Free quotes,
No job too small,*

The Mouse House,
Bradfield St Clare,
Bury St Edmunds,
Suffolk
IP30 0EL

Tel 01284 388508
Mob 07961 878564

Nicholson
Executive Travel

Professional Chauffeur Service

- * Airports and Seaports
- * Business Travel
- * Any UK Destination
- * Accounts Welcomed

Tel: 01359 232648
07850 370465

Email: roger.nicholson1964@gmail.com

Parish Report - March 2020

Councillor Penny Otton
Meadowside
High Street
Rattlesden, Bury St Edmunds
IP30 0RA
Telephone: 07545 423847
Email: penny.otton@suffolk.gov.uk



COVID-19 Update

Latest Government advice: www.gov.uk/coronavirus

Latest SCC information: www.suffolk.gov.uk/coronavirus-covid-19/

Virtual SCC Meetings

SCC will be holding some meetings virtually. Public meetings can still be attended by members of the public and links to virtual meetings will be included on the corresponding agenda. If meetings are cancelled, the Chief Executive will use her emergency powers to make any necessary decisions on behalf of the Cabinet/Council through the delegated decision-making process. Details of any decisions made will be published on the SCC website.

I have been having regular meetings with the chief executive and group leaders to raise any issues and receive updates. I have also held virtual meetings with the directors which have been extremely informative. Staff at SCC have worked tirelessly dealing with all that has been thrown at them, whilst continuing to do their day jobs.

Waste Sites

These are now open and, so far, the booking system has worked ok. Let me know of any problems. Brown bin collections have also started again. ***I would remind everyone that, under the CV19 legislation, it is illegal to have bonfires.***

Supply of PPE

SCC are supplying emergency PPE to all primary care providers unable or struggling to source their own supplies. More information on eligibility, and how to make an order, is available at:

www.suffolk.gov.uk/coronavirus-covid-19/suffolks-response/personal-protective-equipment-for-frontline-workers/

Questions about ordering PPE should be sent to PPE@suffolk.gov.uk

Funding from Government

Suffolk County Council has received £34.7m from the government to help with its coronavirus response. However, the council is currently forecasting the financial impact of the crisis will be at least £56m (due to both extra expenditure and lost income) by the end of March 2021, so more support from the government will be needed.

Parish Report - March 2020

Street Closures to Protect Walkers / Cyclists Exercising Outdoors

My group are encouraging SCC to close roads used by residents for daily exercise, to ensure that walkers / cyclists can exercise safely and maintain social distancing. SCC have indicated they are willing to consider these closures. Ipswich Waterfront has been closed for 3 weeks. If you have suggestions for roads that could benefit from a temporary closure, please let me know and I will pass it on to the Cabinet Member.

Delay to Review of Suffolk County Council Boundaries

The Boundary Commission have announced a delay to the review of SCC's electoral arrangements and division boundaries. Draft recommendations were due for consultation in May-July 2020, with their implementation (including a reduction in councillor numbers) at the 2021 local elections. Given the delay, the new arrangements will not be implemented until 2025.

Cost of Post-16 Home to School Transport Increases by £90

Plans to increase post-16 school transport charges were approved by the Chief Executive using delegated decision-making powers, because the Cabinet were unable to meet. The cost of mainstream post-16 school transport increases by £90, with a £30 increase for post-16 SEND students, despite the consultation on the proposals indicating 75% of respondents felt the increase would have a negative impact on them. If families are concerned about their ability to pay for school transport, they can apply for the 16-19 Bursary Fund which is managed by post-16 provisions and can support eligible disadvantaged young people by up to £1,200.

A14 Closures

I have sent to all clerks details of the overnight road closures, from 11th May for 12 weeks, and asked them to make this information available.

The Orchard Pothole

I have reported this to Rougham

MID SUFFOLK.

The council is contacting as many small businesses as possible, to make sure they apply for a support grant. The form is very simple. Some businesses have found they are not eligible and we have asked government to close that loophole. If you know of any business in Felsham, suggest they go the website. This includes village halls. Get in touch if you need help on this.

Planning Committees

These will continue virtually, allowing the public to join.

Village Shop

Congratulations to all for keeping the shop going to support your most vulnerable.

GLIDING CLUB

Under new rules, flying can recommence but with distancing rules in place.

Stars and Constellations Word Search

ACRUX	CANCER	HADAR	PROXIMA CENTAURI
ALDEBARAN	CANOPUS	HERCULES	REGULUS
ALPHA CENTAURI	CAPELLA	HYDRA	SAGITTARIUS
ALTAIR	CAPRICORNUS	LALANDE	SCORPIUS
ANDROMEDA	CASSIOPEIA	LEO	SIRIUS
ANTARES	CEPHEUS	LIBRA	SPICA
AQUARIUS	CORONA BOREALIS	ORION	TAURUS
ARCTURUS	CYGNUS	PERSEUS	URSA MAJOR
ARIES	EPSILON ERIDANI	PISCES	URSA MINOR
BARNARDS STAR	EPSILON INDI	POLLUX	VEGA
BETELGEUSE	GEMINI	PROCYON	VIRGO



Megan is a beauty therapist with over 14 years experience. I work from my log cabin in Hitcham, it is situated in a peaceful, rural location and benefits from off-road parking. Treatments are by appointment only. Therefore you are guaranteed complete privacy and your treatment time is exclusively for you!

A variety of treatments include:

- Dermalogica Facials/Reflexology/Spray Tanning
- Jessica Manicure and Pedicure
- Foot Health Maintenance (nail trimming/hard skin removal)
- Eye Treatments/Waxing

Please phone for enquiries and price list.

Megan Pryke
 VTCT, BABTAC
 07876 717 008

A Poem of Thanks

Our Shop

*Felsham Community Store is very fine
On V.E. day on its food we did dine
For lunch sumptuous ham consumed
Tempted by date and apple cake we succumbed
Leaving fresh rhubarb and ginger ice-cream to eventide
It followed our Lavenham quiche which was supreme
accompanied by a glass of sauvignon
No room for Suffolk blue cheese and cheddar crunch
Another day with another glass
All these delights from our local store delivered to our door.
Thank you crew for all you do.*

Sue and Paul Jell

Odd One Out Answers

1. Broccoli is the odd one out, the others are root vegetables.
2. Australia is the odd one out, being in the southern hemisphere, all the others are in the northern hemisphere.
3. Swimming is the odd sport, all the others are played with a ball.
4. The hedgehog is an omnivore and the odd one out, all the others are herbivores.
5. Eggs are the odd one out - cheese, butter and ice cream are made from milk.
6. The dolphin is a mammal and the odd one out, the rest are fish.
7. The book is the odd one out, because it doesn't rhyme with the others - wok, lock and sock.
8. The penguin lives in Antarctica and is the odd one out. All the others live in the Arctic.
9. The trumpet is a brass instrument and the odd one out - the rest are woodwind instruments.
10. Elvis is the odd person out. Whilst he was a global superstar he was never president of the USA. Ronald Regan, George W Bush and John F Kennedy were.

THE 59 CLUB

The 59 CLUB are looking for more people to take part.
We have plenty of numbers available

For those of you that don't know what the 59 Club is, it's based on the winning National Lottery Bonus Ball. Simple pick a number that's currently available from numbers 1-59, and if your chosen number is drawn as part of the bonus ball in the National Lottery Lotto, then your number wins.

We have 2 games per week. One on a Wednesday & one on Saturday.

The Wednesday game is charged at 50p per number and if your number comes up you win £15. The Saturday game is charged at £1 per number and for that game if your number is drawn you win £30.

The 59 Club is run on behalf of the Village Hall Management Committee, and raises funds for the Village Hall. So every little bit really does help!

If you would like to take part, or need more information, please get in contact with me: steven1515@yahoo.co.uk or 01449737040.

Thank you, Steven



Bonus Ball Game

New Members Always Welcome To Join.



The 59 Club is run on behalf of the Village Hall Management Committee to help maintain, repair & the upkeep of our lovely village hall

The CleanPlumber

experience the difference

**Installations, Service & Repairs
Domestic & Commercial...**

- Gas, Oil and LPG Boilers
- Central Heating
- Power Flushing of Radiators
- Gas Safe and Oftec registered
- Showers & Bathrooms
- Property Maintenance

A leaking tap to a brand new system – we can help you

**Call us now on
01284 765453**

www.thecleanplumber.co.uk

Apple Tree Cottage

Lower Green
Felsham



**Buy High Welfare Meat Locally!
All raised in Felsham & Gedding**

**Beef
Goat & Kid
Lamb Hogget Mutton
Pork Gammon Bacon**

Tel: 01449 737793 (leave a message if we are not in and we WILL get back to you)

Bus Times

To / From Bury St Edmunds		Mon	Tue	Wed	Thu	Fri	Sat	Sun
379	OUTWARD							
	Felsham Six Bells			10:38				
	Gedding Bus Stop			10:41				
	Bury Bus Station			11:07				
379	RETURN							
	Bury Bus Station, Stand 5			12:55				
	Gedding Bus Stop			13:19				
	Felsham Six Bells			13:22				

Crawford Electrical Contractor



Mark Crawford

Domestic and Commercial Electrician

Telephone: 01449 736043 / 07811 897878

EE Electrical

Digestive Issues: Did you know that in a lot of cases... There's a pattern emerging here... Good Nutrition is key in supporting your health!



If you would like to have a free initial consultation by phone or face-to-face, you can do so at **Woolpit Complementary** by calling or emailing.

Call Emma on 07760 124 519 to find out more.

Emma Harvey Lawrence (Nutritionist)
BSc (Hons), ANutr, MNS
emma@nutrition-creative.co.uk

Nutrition Creative 

Village Directory

ALLOTMENTS	BRIAN FRANCIS	01449 736219
CARPET BOWLS	TREVOR DORES	01449 737936
ST PETER'S CHURCH, FELSHAM	REVEREND SHARON POTTER	01284 828599
ST MARY'S CHURCH, GEDDING	revsharon@btinternet.com	
CHURCH WARDENS	DAVID WILLIAMS (FELSHAM)	01449 737778
	JAMES MORGAN (GEDDING)	01449 737445
DOCTORS SURGERY	WOOLPIT HEALTH CENTRE, HEATH ROAD, WOOLPIT	01359 240298
PHARMACY	WOOLPIT HEALTH CENTRE, HEATH ROAD, WOOLPIT	01359 242394
F&G Community Store & Post Office		01449 736042
F&G FUEL GROUP	pawlinson@btinternet.com	01449 736330
FACEBOOK	FELSHAM & GEDDING COMMUNITY	
FAGENDS	c/o DAVID WILLIAMS	01449 737778
FELSHAM CHARITY	DAVID WILLIAMS	01449 737778
GEDDING PARISH MEETING	GILLY MORGAN	01449 737445
MEMBER OF PARLIAMENT	JO CHURCHILL 10 HATTER STREET, BURY ST EDMUNDS IP33 1LZ	01284 752311
MID SUFFOLK & COUNTY COUNCILLOR	PENNY OTTON penny.otton@suffolk.gov.uk penny.otton@midsuffolk.gov.uk	01449 736482
MID SUFFOLK DISTRICT COUNCIL	NEEDHAM MARKET	0845 606 6170
FELSHAM PARISH COUNCIL	SIMON GARROD, CHAIR	01449 737728
	PAULA GLADWELL, CLERK. GREEN FARM BARN, COCKFIELD felshamparishclerk@gmail.com	01284 828112
PLAYING FIELD	PHILIP COCKELL, CHAIR	01449 671872
SHELTERED HOUSING	MID SUFFOLK DISTRICT COUNCIL	01473 826639
POLICE	SAFER NEIGHBOURHOOD TEAM ONE stowmarket.snt@suffolk.pnn.police.uk	101 999 (emergency)
TABLE TENNIS	ADRIAN KING	01449 737495
TREE WARDEN	MARK TAVERNOR, mtavernor@btinternet.com	01449 737793
VILLAGE E.VINE	faddb1011@btinternet.com	
VILLAGE HALL	ANDREW CONQUEST, CHAIR	01449 737619
	KEN SPARKES, CARETAKER	01449 736373
	DAVID WILLIAMS, BOOKINGS	01449 737778
VILLAGE WEBSITES	FELSHAM: felsham.onesuffolk.net	
	GEDDING: gedding.onesuffolk.net	
WHIST DRIVE	PAT CLARKE	01449 736202
WOMEN'S INSTITUTE	ALISON SHAW	01284 827034
YOGA	PAT CLARKE	01449 736202